



solutions holding
your ideas.

INDEX

3 | STANDARDS AND ACCESSORIES
Base jack, swivel base jack and scaffold castors
Collars
Standards
Base jack attachments and scaffold connectors

6 | DIAGONAL BRACES
Diagonal braces

LEDGERS
Ledgers and bridging ledgers
Lattice and walkway beams

9 | STEEL DECKS & ACCESS DECKS
Steel decks and non perforated steel decks
Slim steel decks
Double decks
Access decks
Corner decks
Deck Retainer

12 | TOE BOARDS
Metallic and wood toe boards

13 | STAIRCASES
Staircases, handrails and guardrails for staircases

14 | ADVANCE GUARDRAILS
Advance guardrails

15 | CONSOLE BRACKETS
Console brackets

15 | SHORING
Shoring heads

16 | COUPLERS, ACCESSORIES & SPARE PARTS
Couplers and accessories
Rubbish retaining
Clamp for advertising
Spigots for jolting standards and lattice beams
Spare parts
Galvanized tubes
Scaffolding net

14 | MAINTENANCE
Universal Pallet



BASE JACK



Ref.	Spindle height (cm)	Weight (kg)	Price (€)
AA.BN.500	50 (Max. spindle: 30)	3,10	14,30
AA.BN.700	70 (Max. spindle: 50)	3,70	17,30

SWIVEL BASE JACK



Ref.	Spindle height (cm)	Weight (kg)	Price (€)
AA.BNA.650	65 (Max. spindle: 45)	4,20	30,00

SCAFFOLD CASTOR



Ref.	Load capacity (kg)	Weight (kg)	Price (€)
AA.RNT.750	Broken: 750 Unbroken: 400	5,80	82,00



BASE COLLAR



Ref.	Description	Weight (kg)	Price (€)
US.CL	Regular collar	1,60	8,80
US.CL.LO	Long collar	2,20	16,50

STANDARD

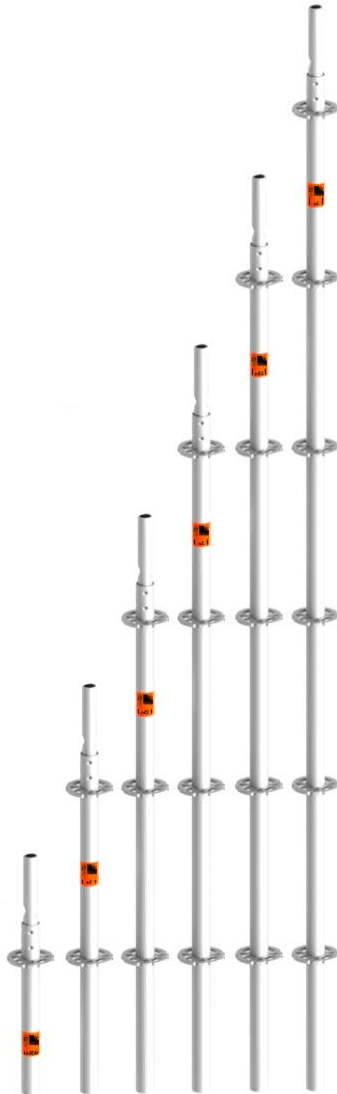

Ref.	Height (cm)	Weight (kg)	Price (€)
US.VT.500	50	3,40	13,45
US.VT.1000	100	5,80	18,90
US.VT.1500	150	8,10	26,20
US.VT.2000	200	10,50	34,10
US.VT.2500	250	12,80	42,00
US.VT.3000	300	15,20	50,00

STANDARD WITHOUT SPIGOT

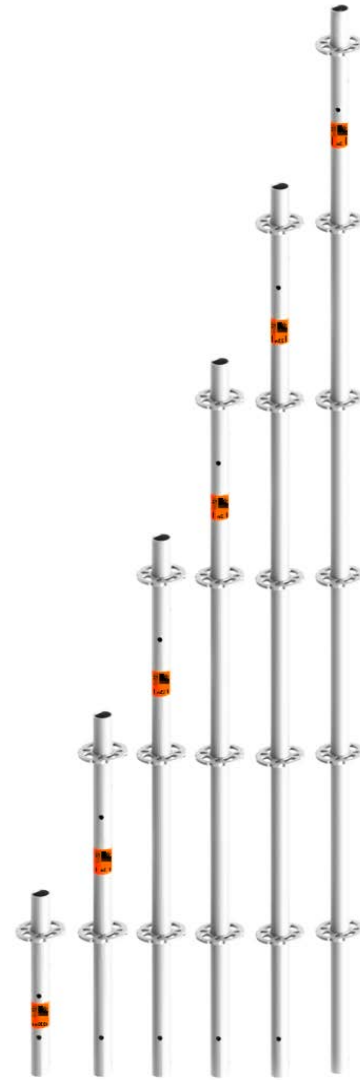

Ref.	Height (cm)	Weight (kg)	Price (€)
US.VTS.500	50	2,20	11,00
US.VTS.1000	100	4,70	17,45
US.VTS.1500	150	7,00	24,90
US.VTS.2000	200	9,40	32,70
US.VTS.2500	250	11,70	40,80
US.VTS.3000	300	14,00	48,70



Index

BASE JACK ATTACHMENT WITH COLLAR FOR LIFTING



Ref.

US.FBC.I

Weight (kg)

0,84

Price (€)

11,40

BASE JACK ATTACHMENT WITH STANDARD FOR LIFTING



Ref.

US.FBV.I

Weight (kg)

1,60

Price (€)

17,00

SUSPENDED SCAFFOLD CONNECTOR



Ref.

US.AV

Weight (kg)

3,60

Price (€)

19,80

DIAGONAL BRACE



Heigth 200 (cm)

Width (cm)

Weight (kg)

Price (€)

US.DG.2000.730

73

7,60

28,80

US.DG.2000.1090

109

8,00

30,10

US.DG.2000.1400

140

8,40

30,90

US.DG.2000.1570

157

8,60

30,90

US.DG.2000.2070

207

9,50

33,30

US.DG.2000.2570

257

10,50

36,10

US.DG.2000.3070

307

11,60

38,60

Heigth 150 (cm)

Width (cm)

Weight (kg)

Price (€)

US.DG.1500.730

73

6,30

25,90

US.DG.1500.1090

109

6,80

26,90

US.DG.1500.1400

140

7,20

28,40

US.DG.1500.1570

157

7,60

28,40

US.DG.1500.2070

207

8,60

31,60

US.DG.1500.2570

257

9,70

34,15

US.DG.1500.3070

307

10,90

36,90

Heigth 100 (cm)

Width (cm)

Weight (kg)

Price (€)

US.DG.1000.730

73

5,10

23,20

US.DG.1000.1090

109

5,70

24,60

US.DG.1000.1400

140

6,20

26,40

US.DG.1000.1570

157

6,70

26,40

US.DG.1000.2070

207

7,90

29,40

US.DG.1000.2570

257

9,10

32,75

US.DG.1000.3070

307

10,40





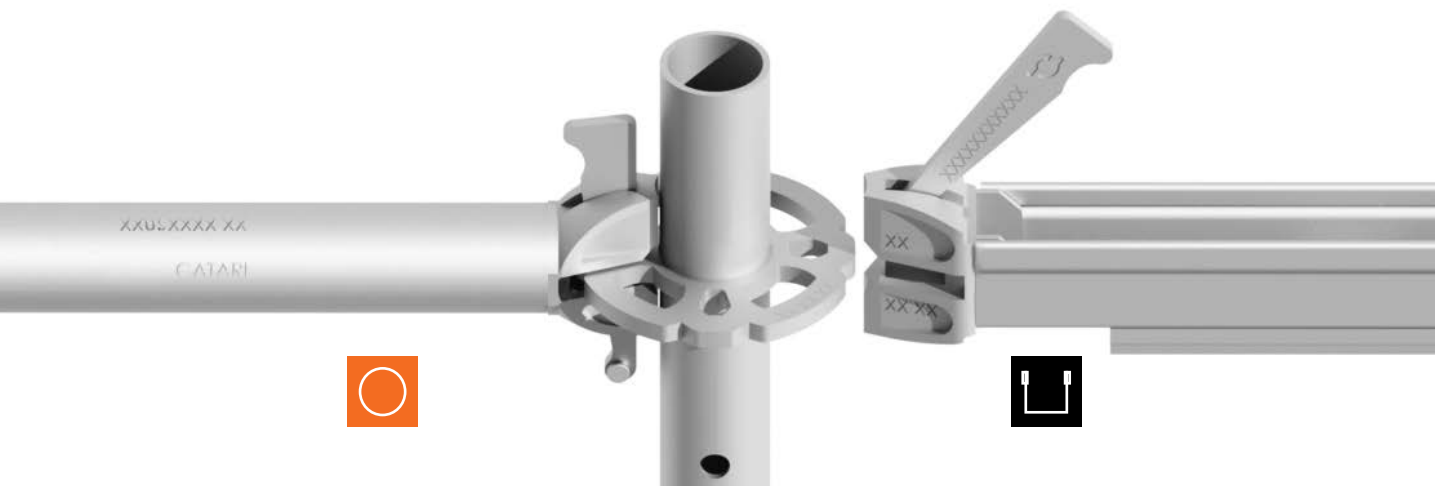



35,65







LEDGER



Ref.	Width (cm)	Weight (kg)	Price (€)
US.HZ.0420	42 	1,80	17,00
US.HZ.0730	73 	2,90	14,00
US.HZ.1090	109 	4,10	17,20
US.HZ.1400	140 	5,20	21,20
US.HZ.1570	157 	5,70	21,20
US.HZ.2070	207 	7,40	24,30
US.HZ.2570	257 	9,10	28,50
US.HZ.3070	307 	10,90	32,30

LEDGER





Ref.	Width (cm)	Weight (kg)	Price (€)
US.HZ.U.0420	42 	2,00	17,00
US.HZ.U.0730	73 	3,00	14,00



US.HZ.U.1090	109 	5,10	21,30
US.HZ.U.1400	140 	6,20	35,70



US.HZ.U.1570	157 	7,90	45,00
US.HZ.U.2070	207 	11,00	56,00
US.HZ.U.2570	257 	14,20	68,00









INTERMEDIATE LEDGER DECK TO DECK



Ref.	Width (cm)	Weight (kg)	Price (€)
US.HZ.PP.0420	42 	2,40	19,50
US.HZ.PP.0730	73 	3,50	22,00
US.HZ.PP.1090	109 	4,60	27,00



BRIDGING LEDGER



Ref.	Width (cm)	Weight (kg)	Price (€)
US.VP.1570 	1570	10,20	39,65
US.VP.2070 	2070	13,90	51,85
US.VP.2570 	2570	17,50	60,60
US.VP.3070 	3070	21,10	72,80
US.VP.U.1570 	1570	10,10	39,65
US.VP.U.2070 	2070	13,60	51,85
US.VP.U.2570 	2570	17,10	60,60
US.VP.U.3070 	3070	20,60	72,80

INTERMEDIATE LEDGER TUBE TO TUBE







Ref.	Width (cm)	Weight (kg)	Price (€)
US.HZ.TT.0730	73 	3,40	17,60
US.HZ.TT.1090	109 	4,60	20,00









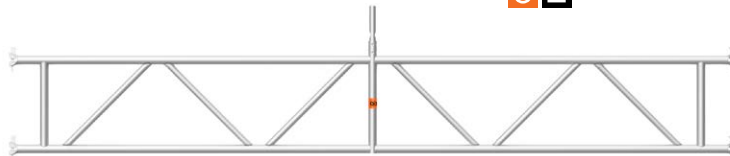

LEDGER 35°



Ref.		Weight (kg)	Price (€)
US.HZ.730.35.E	73 - Right 	3,00	18,00
US.HZ.730.35.D	73 - Left 	3,00	18,00
US.HZ.U.730.35.D	73 - Right 	3,10	18,00
US.HZ.U.730.35.E	73 - Left 	3,10	18,00

LATTICE BEAM WITH 4 WEDGE HEADS



Ref.	Width (cm)	Height (cm)	Weight (kg)	Price (€)
US.VS.1090 	109	50	13,50	110,00
US.VS.3070 	307	50	29,90	173,00
US.VS.4140 	414	50	45,30	225,00
US.VS.5140 	514	50	55,20	275,00
US.VS.6140 	614	50	65,00	320,00
US.VS.U.4140 	414	50	43,00	225,00
US.VS.U.5140 	514	50	52,30	275,00
US.VS.U.6140 	614	50	61,50	320,00

WALKWAY BEAM



Ref.	Width (cm)	Height (cm)	Weight (kg)	Price (€)
US.VP 	157	50	20,80	125,00
US.VPU 	157	50	20,70	125,00

STEEL LATTICE BEAM



Ref.	Width (cm)	Height (cm)	Weight (kg)	Price (€)
AA.VP.2000	200	45	20,60	81,60
AA.VP.3000	300	45	28,20	106,70
AA.VP.4000	400	45	39,90	130,80
AA.VP.5000	500	45	48,90	162,00
AA.VP.6000	600	45	59,20	187,00
AA.VP.5000.75	500	75	57,30	253,00
AA.VP.6000.75	600	75	69,80	293,00





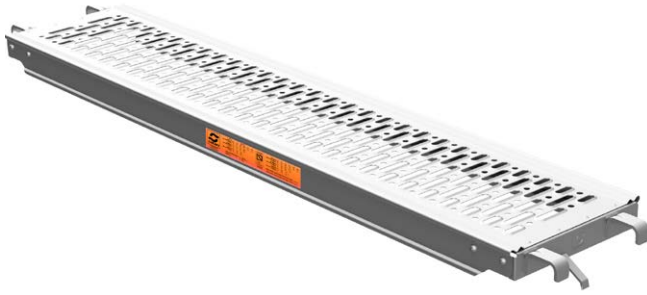





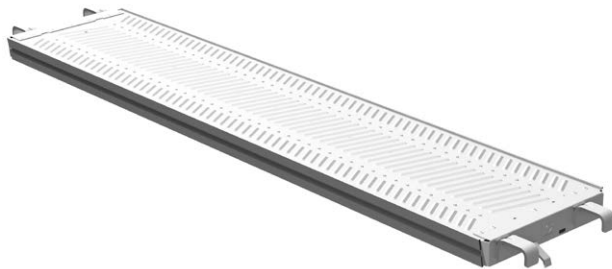



STEEL DECK



Ref.	Width (cm)	Standard Length (cm)	Class	Weight (kg)	Price (€)
US.PL.0730 	32*	73	6	6,20	37,00
US.PL.1090 		109	6	8,50	38,00
US.PL.1400 		140	6	10,60	39,00
US.PL.1570 		157	6	11,70	39,00
US.PL.2070 		207	6	15,00	45,00
US.PL.2570 		257	5	18,80	50,00
US.PL.3070 		307	5	22,00	55,00
FA.PL.0730 		73	6	5,80	35,00
FA.PL.1090 		109	6	8,20	36,00
FA.PL.1400 		140	6	10,30	37,00
FA.PL.1570 		157	6	11,40	37,00
FA.PL..2070 		207	6	14,60	43,00
FA.PL.2570 		257	5	18,40	48,00
FA.PL.3070 		307	5	21,70	53,00

NON PERFORATED STEEL DECK







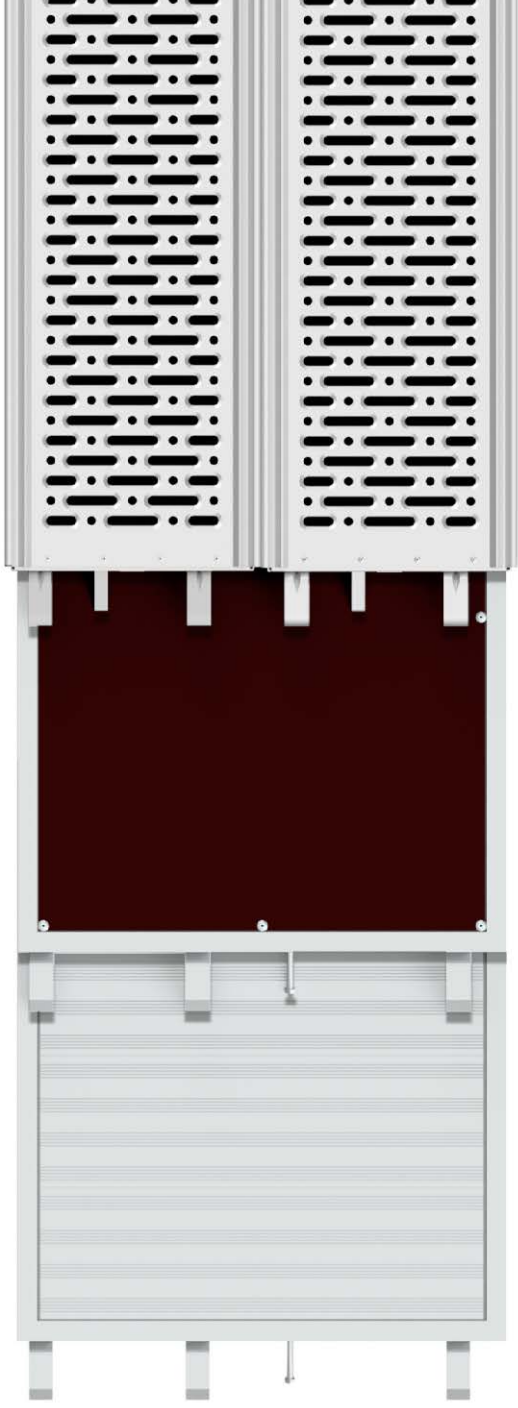



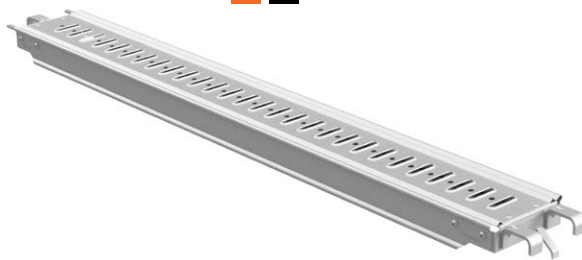

Ref.	Width (cm)	Length (cm)	Class	Weight (kg)	Price (€)
US.PL.320.0730 	32*	73	6	5,90	35,00
US.PL.320.1090 		109	6	7,90	36,00
US.PL.320.1570 		157	6	10,70	38,00
US.PL.320.2070 		207	6	13,50	41,00
US.PL.320.2570 		257	4	16,60	44,00
US.PL.320.3070 		307	3	19,50	47,00
FA.PL.320.0730 		73	6	5,60	34,00
FA.PL.320.1570 		157	6	10,30	37,00
FA.PL.320.2070 		207	6	13,20	40,00
FA.PL.320.2570 		257	4	16,30	43,00
FA.PL.320.3070 	307	3	19,20	46,00	





SLIM STEEL DECK







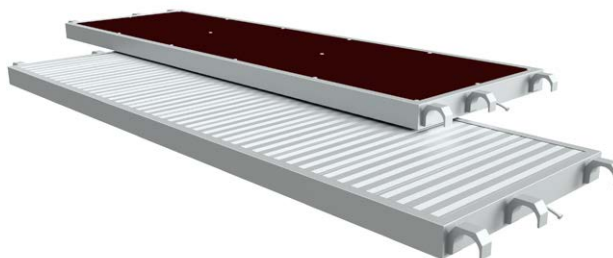



Ref.	Width (cm)	Length (cm)	Weight (kg)	Price (€)
US.PL.190.1090 	19	109	6,90	39,10
US.PL.190.1570 		157	9,60	40,25
US.PL.190.2070 		207	12,40	41,40
US.PL.190.2570 		257	15,30	47,15
US.PL.190.3070 		307	18,10	50,60
FA.PL.190.1570 		157	9,40	39,25
FA.PL.190.2070 		207	12,20	40,40
FA.PL.190.2570 		257	15,10	46,15
FA.PL.190.3070 		307	17,90	49,60









DOUBLE DECKS



PLYWOOD

Ref.	Width (cm)	Length (cm)	Class	Weight (kg)	Price (€)
US.PAM.1570 	61	157	3	13,10	86,25
US.PAM.2070 		207	3	16,80	106,00
US.PAM.2570 		257	3	20,50	115,00
US.PAM.3070 		307	3	25,70	134,00
FA.PAM.1570 		157	3	12,70	87,00
FA.PAM.2070 		207	3	16,40	106,00
FA.PAM.2570 		257	3	20,10	115,00
FA.PAM.3070 		307	3	25,30	134,00



ALUMINIUM

Ref.	Width (cm)	Length (cm)	Class	Weight (kg)	Price (€)
US.PAA.1570 	61	157	3	11,40	110,00
US.PAA.2070 		207	3	14,70	130,00
US.PAA.2570 		257	3	17,80	160,00
US.PAA.3070 		307	3	22,40	185,00
FA.PAA.1570 		157	3	11,00	110,00
FA.PAA.2070 		207	3	14,30	130,00
FA.PAA.2570 		257	3	17,40	160,00
FA.PAA.3070 		307	3	22,00	185,00



ACCESS DECK 1,09 M



Ref.	Width (cm)	Length (cm)	Class	Weight (kg)	Price (€)
US.PA.1090 	61	109	3	10,20	140,00
US.PA.AL.1090 	61	109	3	10,20	185,00







ACCESS DECKS



PLYWOOD

Ref.	Length (cm)	Class	Weight (kg)	Price (€)
US.PA.2070 	207	3	17,40	160,00
US.PA.2570 	257	3	24,10	200,00
US.PA.3070 	307	3	29,30	235,00
FA.PA.2070 	207	3	17,00	160,00
FA.PA.2570 	257	3	23,70	200,00
FA.PA.3070 	307	3	28,90	235,00







ALUMINIUM

Ref.	Width (cm)	Length (cm)	Class	Weight (kg)	Price (€)
US.PA.AL.2070 	61	207	3	16,10	229,00
US.PA.AL.2570 		257	3	22,30	269,00
US.PA.AL.3070 		307	3	26,90	299,00
FA.PA.AL.2070 		207	3	15,80	229,00
FA.PA.AL.2570 		257	3	21,90	269,00
FA.PA.AL.3070 		307	3	26,50	299,00

LATERAL ACCESS DECK



ALUMINIUM

Ref.	Width (cm)	Length (cm)	Class	Weight (kg)	Price (€)
US.PA.AL.LA.2070 	61	207	3	14,80	234,00
US.PA.AL.LA.2570 		257	3	23,00	274,00
US.PA.AL.LA.3070 		307	3	27,50	304,00
FA.PA.AL.LA.2070 		207	3	14,40	234,00
FA.PA.AL.LA.2570 		257	3	22,60	274,00
FA.PA.AL.LA.3070 		307	3	27,10	304,00

ALUMINIUM LADDER FOR ACCESS DECK

The access decks *US.PA* and *FA.PA* of 1090 and 2070 are sold separately from the ladder.





Ref.	Height (cm)	Weight (kg)	Price (€)
AA.EA	200	3,20	40,00
AA.EA.3000	300	6,10	44,00

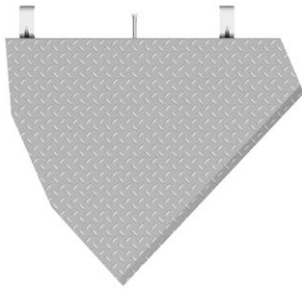

ANGULAR DECK 0/45°



Ref.	Width (cm)	Weight (kg)	Price (€)
US.PL.CA.0/45 	61	6,10	58,00
FA.PL.CA.0/45 		6,40	58,00

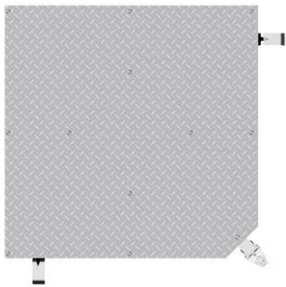

CORNER DECK 90°

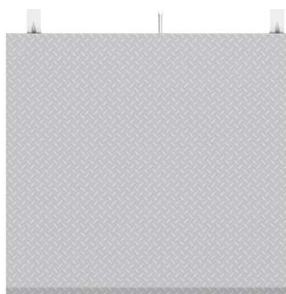

Ref.	Width (cm)	Weight (kg)	Price (€)
US.PL.CA.90 	61	9,00	110,00

CONNECTION PLATFORM









Ref.	Width (cm)	Weight (kg)	Price (€)
US.PL.LC 	61	9,60	46,00
FA.PL.LC 		9,70	45,00



DECK RETAINER



Ref.	Width (cm)	Weight (kg)	Price (€)
US.FS.0420 	42	0,66	8,50
US.FS.0730 	73	1,30	13,35
US.FS.1090 	109	1,90	14,90
US.FS.1400 	140	2,50	22,55
US.FS.1570 	157	2,80	28,45
US.FS.2070 	207	4,50	35,45
US.FS.2570 	257	5,80	40,40
US.FS.3070 	307	7,10	45,50

METALLIC TOE BOARD



Ref.	Length (cm)	Weight (kg)	Price (€)
US.RPM.0420	42	1,30	12,10
US.RPM.0730	73	2,10	12,10
US.RPM.1090	109	3,00	13,15
US.RPM.1400	140	3,70	14,20
US.RPM.1570	157	4,20	14,20
US.RPM.2070	207	5,40	16,00
US.RPM.2570	257	8,20	18,00
US.RPM.3070	307	9,80	21,00









WOOD TOE BOARD



Ref.	Length (cm)	Weight (kg)	Price (€)
US.RP.0420	42	1,50	11,40
US.RP.0730	73	2,50	11,40
US.RP.1090	109	3,60	12,40
US.RP.1400	140	4,60	13,40
US.RP.1570	157	5,10	13,40
US.RP.2070	207	6,60	14,40
US.RP.2570	257	8,20	16,60
US.RP.3070	307	9,70	19,20

STAIRCASES



Ref.	Width (cm)	Length (cm)	Weight (kg)	Price (€)
US.EP.2570 	257	62	26,00	311,00
US.EP.3070 	307	62	30,80	363,00
US.EP.1000.620 	When the flight is smaller than 200 cm		14,60	180,00
US.EP.2000.960.2570 	257	96	40,50	450,00
US.EP.2000.960.3070 	307	96	48,20	520,00
US.EP.1000.960 	When the flight is smaller than 200 cm		23,20	320,00
FA.EP.2570 	257	62	25,70	311,00
FA.EP.3070 	307	62	30,50	363,00
FA.EP.1000.620 	When the flight is smaller than 200 cm		14,50	180,00

HANDRAIL FOR STAIRCASE

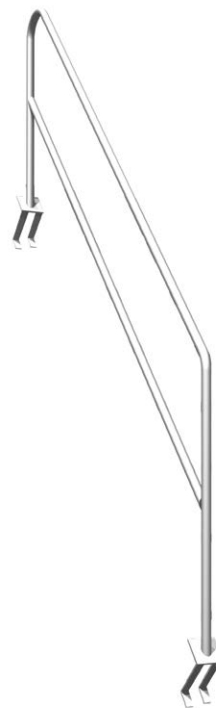

Ref.	Description	Weight (kg)	Price (€)
AA.CE.1000	100 cm (use with US.EP.1000.620)	5,70	31,20
AA.CE.2000	200 cm (use with the others US.EP.XXXX and/or FA.EP.XXXX)	8,40	39,00

UPSTAIRS GUARDRAIL



Ref.	Extension (cm)	Weight (kg)	Price (€)
US.OP	Telescopic from 257 up to 307 cm	10,50	43,20



ADVANCE GUARDRAIL POST (ALUMINIUM)



Ref.	Weight (kg)	Price (€)
AA.GCMP	4,90	180,00

ADVANCE GUARDRAIL (ALUMINIUM)



Ref.	Extension (cm)	Weight (kg)	Price (€)
AA.TEGM.1570.2070	157 up to 207 (AL)	2,00	65,00
AA.TEGM.2570.3070	257 up to 307 (AL)	2,60	70,00

DEFINITIVE ADVANCE GUARDRAIL

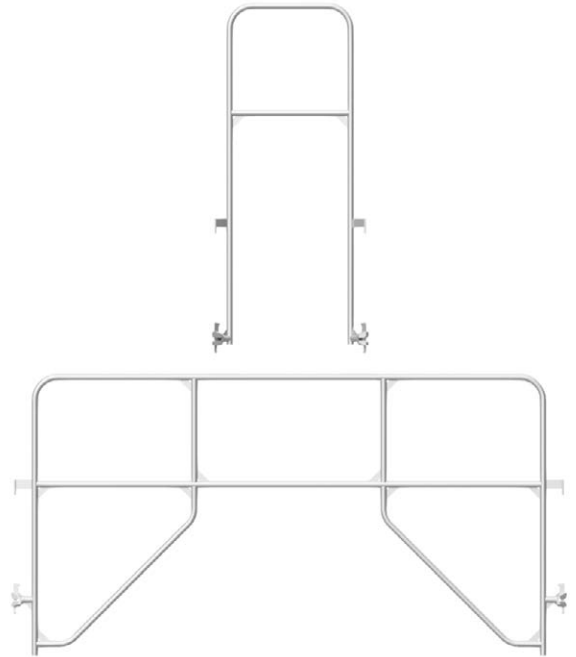







Ref.	Length (cm)	Weight (kg)	Price (€)
US.GCMD.730	730	5,90	44,40
US.GCMD.1090	1090	6,70	49,20
US.GCMD.1570	1570	9,10	69,60
US.GCMD.2070	2070	11,20	74,40
US.GCMD.2570	2570	12,90	79,20
US.GCMD.3070	3070	14,00	82,80



CONSOLE BRACKETS



Ref.	Length (cm)	Weight (kg)	Price (€)
US.CL.320 	32	4,60	21,80
US.CL.730 	73	6,20	27,25
US.CL.1090 	109	11,20	60,00
US.CL.U.320 	32	4,60	21,80
US.CL.U.730 	73	6,20	27,25
US.CL.U.1090 	109	11,20	60,00

BRACKET BRACE



Ref.	Length (cm)	Weight (kg)	Price (€)
AA.TC	73	7,20	28,00



CROSS HEAD JACK FOR H20 BEAM



Ref.	Spindle height (cm)	Weight (kg)	Price (€)
US.CR	Spindle 70 cm (Max. spindle: 47,5 cm)	6,20	35,55

HEAD JACK



Ref.	Spindle height (cm)	Weight (kg)	Price (€)
US.CR.U	Spindle 70 cm (Max. spindle: 47,5 cm)	6,90	27,50

ADJUSTABLE SPINDLE & U HEAD



Ref.	Description	Weight (kg)	Price (€)
US.FR.850	Spindle 85 cm (Max. spindle: 60 cm)	3,40	19,65
US.CU	U head	4,10	17,35

DOUBLE COUPLER



Ref.	Weight (kg)	Price (€)
AA.OT.48	1,30	4,35

TWIN WEDGE COUPLER



Ref.	Weight (kg)	Price (€)
US.TD	0,90	16,00

SWIVEL COUPLER



Ref.	Weight (kg)	Price (€)
AA.OG.48	1,30	4,90

LOCKING PIN (PIG TAIL)



Ref.	Weight (kg)	Price (€)
AA.PS	0,08	0,35

ROSETTE COUPLER

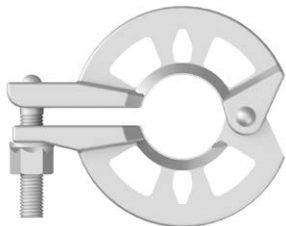

Ref.	Weight (kg)	Price (€)
AA.AROSE	1,20	10,40

HINGED PIN



Ref.	Weight (kg)	Price (€)
AA.PS.ML	0,05	2,00



CLAW COUPLER



Ref.	Weight (kg)	Price (€)
AA.AP.GA	1,10	9,00

SWIVEL COUPLER FOR PROFILE WITH BOLT



Ref.	Weight (kg)	Price (€)
AA.APG	2,10	13,80

PROFILE COUPLER WITH BOLT



Ref.	Weight (kg)	Price (€)
AA.AP	1,90	13,20

WALL TIE



Ref.	Length (cm)	Weight (kg)	Price (€)
AA.GA.250	25	1,10	4,00
AA.GA.300	30	1,30	4,40
AA.GA.500	50	2,10	6,30
AA.GA.1000	100	3,90	11,10
AA.GA.1500	150	5,80	15,75
AA.GA.2000	200	7,60	20,50

RING SCREW



Ref.	Length (cm)	Weight (kg)	Price (€)
AA.OL.120	12	0,18	1,40
AA.OL.190	19	0,24	1,65
AA.OL.280	28	0,31	2,15
AA.OL.350	35	0,37	2,65
AA.OL.400	40	0,42	3,30

STOPPER



Ref.	Length (cm)	Weight (kg)	Price (€)
AA.BC.80	8	0,01	0,27
AA.BC.100	10	0,01	0,30



SPIGOT FOR JOINTING



Ref.	Weight (kg)	Price (€)
AA.EE	0,85	5,20

U-LEDGER WITH COUPLERS



Ref.	Lenght (cm)	Weight (kg)	Price (€)
AA.CA.730	73 (non reinforced)	3,40	17,00
AA.CA.1090	109 (reinforced)	5,50	23,00

SLEEVE COUPLER



Ref.	Weight (kg)	Price (€)
AA.AD.48	1,40	7,10

JACK WITH COUPLER



Ref.	Height (cm)	Weight (kg)	Price (€)
AA.NA	70	3,50	18,80

COUPLER WITH SPIGOT

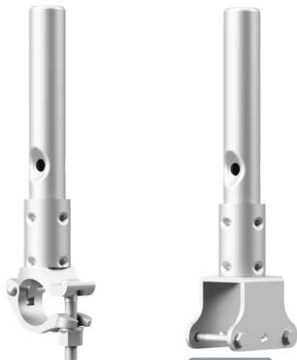

Ref.	Weight (kg)	Price (€)
US.AE	1,70	15,75
US.AE.U	1,70	20,40



CLAMP FOR RUBBISH RETAINING



Ref.	Tube Ø	Weight (kg)	Price (€)
AA.GRE	Ø48 mm	12,30	55,00

CLAMP FOR ADVERTISING

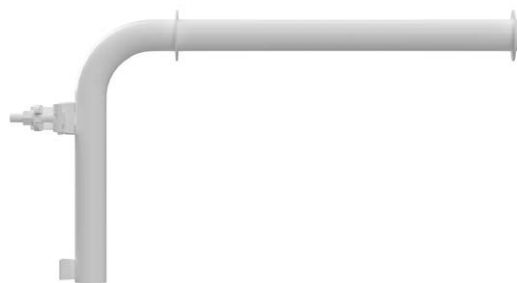

Ref.	Weight (kg)	Price (€)
AA.GFPP	4,30	18,50

SPIGOT FOR JOINTING STANDARDS



Ref.	Weight (kg)	Price (€)
US.EC	2,40	11,00

CLIP FOR METAL SHEET FIXING



Ref.	Tube Ø	Weight (kg)	Price (€)
AA.GFC.48	Ø48 mm	0,21	2,60

SPIGOT FOR JOINTING LATTICE BEAM



Ref.	Weight (kg)	Price (€)
AA.VPEC	2,20	11,00



L COUPLER



Ref.	Weight (kg)	Price (€)
AA.L	2,70	21,00

FITTING COUPLER

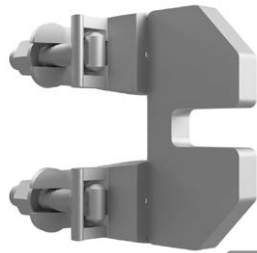

Ref.	Weight (kg)	Price (€)
AA.FT	2,50	20,50

COUPLER FOR STEPS



Ref.	Weight (kg)	Price (€)
AA.AG	2,50	15,00



UNIVERSAL PALLET BASIC TYPE



Ref.	Width (cm)	Length (cm)	Height (cm)	Weight (kg)	Price (€)
PU.B	85	120	92	44,70	131,00

UNIVERSAL PALLET WITH MESH CRATE



Ref.	Width (cm)	Length (cm)	Height (cm)	Weight (kg)	Price (€)
PU.RD	85	120	92	100,10	302,00

CENTRAL SUPPORT FOR UNIVERSAL PALLET



Ref.	Width (cm)	Height (cm)	Weight (kg)	Price (€)
PU.SC	85	82	9,20	26,45

LATERAL MESH CRATE PANEL

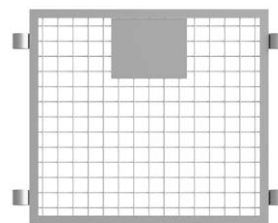

Ref.	Width (cm)	Height (cm)	Weight (kg)	Price (€)
PU.RL	85	71	7,70	35,00

FRONT MESH CRATE PANEL

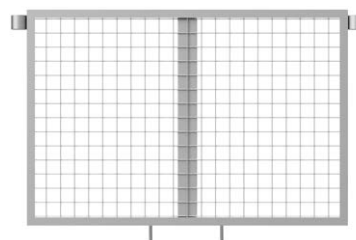

Ref.	Length (cm)	Height (cm)	Weight (kg)	Price (€)
PU.RF	120	77	10,90	44,00

BOTTOM FOR UNIVERSAL PALLET



Ref.	Length (cm)	Width (cm)	Weight (kg)	Price (€)
PU.CF	120	85	18,20	34,15



T-BOLT FOR COUPLER



Ref.	Weight (kg)	Price (€)
AA.AB.PA	50 units	4,90
		31,00

NUT FOR T-BOLT



Ref.	Weight (kg)	Price (€)
AA.AB.PO	100 units	4,40
		43,90

WEDGES



Ref.	Weight (kg)	Price (€)
US.TE.CU	25 units	3,25
		41,30

RIVET FOR WEDGE



Ref.	Weight (kg)	Price (€)
US.TE.CR	100 units	0,30
		20,60

SCREW WITH NUT



Ref.	Weight (kg)	Price (€)
AA.PP.12.65	0,09	0,70

GALVANIZED TUBE



Ref.	Length (cm)	Weight (kg)	Price (€)
AA.TU.0500.G	50	1,90	5,45
AA.TU.1000.G	100	3,70	10,20
AA.TU.1500.G	150	5,60	14,90
AA.TU.2000.G	200	7,40	19,50
AA.TU.2500.G	250	9,40	24,20
AA.TU.3000.G	300	11,20	28,80
AA.TU.4000.G	400	15,00	38,10
AA.TU.5000.G	500	18,70	47,55
AA.TU.6000.G	600	22,30	57,10

SCAFFOLDING NET

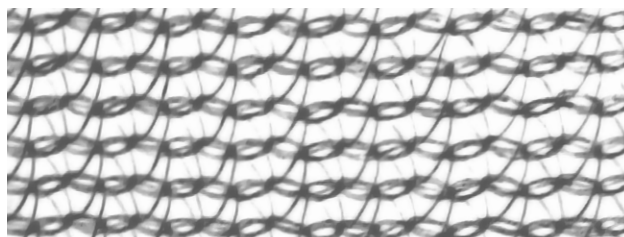

Ref.	Height (cm)	Length (cm)	Price (€)
AA.RM.4000	400	10000	0,75/m ²





solutions holding **your ideas.**



solutions holding your ideas.

www.catari.pt

MADE IN EUROPEAN UNION



PORTUGAL

Zona Industrial do Rossio - Av. da Industria
3730-600 Vale de Cambra

phone: (+351) 256 420 890
e-mail: info@catari.pt

The images are for illustration purposes only and may not perfectly or accurately depict a realistic object or process. The illustrations are purposely designed to demonstrate a principle or sequence of steps so that the viewer has a better understanding. Details may be simplified or omitted, scale may be resized.



universal
SYSTEM

© Catari 2016

Art director: Stéphane Leite
All content on this catalogue, such as text, graphics, logos, and images is the property of Catari Indústria, S.A. or its content suppliers and protected by copyright law of the European Union.

www.catari.pt